





Meden-Inmed was founded in 1989 as a company employing two people. Since then, it has gained a strong market position through our hard work and reliability. Initially a small distributor of a few renowned manufacturers, now a dynamic medium-sized company with over 190 employees - professionals in the fields of electronics, mechanics, design, economy, sales and marketing.

Modern rehabilitation combines specialized knowledge with state of the art technology. We knew that when we started our own production plant in 1996 and are even more convinced of it now, when we create new products and widen our offer of medical devices each year. Therefore, we deliver solutions that are modern, efficient, comfortable and user friendly. We are always happy to see new ideas turn into new products.

Every product we have sold proves the trust our customers have placed in us. Behind every device we deliver there is a long-term relationship. Our customers consciously select a supplier that not only delivers the equipment, but can also guarantee high quality and professional service. It has always been our duty and our motto.

To address the growing needs of our customers we have now expanded the range of our products. Our goal is to deliver you a complete range of equipment required by professionals in the field of rehabilitation. This catalogue shows just a part of our offer and is dedicated to professional treatment tables.

We will help you choose the best equipment that is tailored to your needs. Let this catalogue be your guide to our products. Meden-Inmed's Team will assist you in every matter of our cooperation. We are always here to hear your voice. Your feedback is always welcome and appreciated.

Ph.D. Eng. Wiesław Zinka
President
Meden-Inmed Company

Maciej Zinka
Sales & Marketing
Vice President

Our awards:



European Medal 2016
European Medal 2015
European Medal 2014
European Medal 2013
European Medal 2012
European Medal 2011
European Medal 2010
European Medal 2009
European Medal 2008
European Medal 2007

European Economic and Social
Committee and Business Center Club



Diamond of FORBES Magazine 2009



**Ambassador of Polish Economy
in category:**

Exporter, 2014
XXI century solution creator, 2013
Partner of foreign companies, 2012



Perfect Line 2009 SPA Business



Gazelle of Business 2008
Gazelle of Business 2007
Gazelle of Business 2006



**Awards of biggest rehabilitation
equipment fairs in Poland
- Rehabilitacja Fairs**

XXII Rehabilitacja Łódź 2014
XXI Rehabilitacja Łódź 2013
XVI Rehabilitacja Łódź 2008
XV Rehabilitacja Łódź 2007
XIV Rehabilitacja Łódź 2006
XIII Rehabilitacja Łódź 2005
X Rehabilitacja Łódź 2002
VIII Rehabilitacja Łódź 2000



**5th rank on the list of 100 best
companies in the region**

II Euroregional Economic Presentation
Szczecin 2002



Investment of the year 2009

Polish Federation of Engineering
Associations



Product of West Pomerania 2015
Product of West Pomerania 2012
Product of West Pomerania 2010
Product of West Pomerania 2009
Product of Pomerania 2009
Product of Pomerania 2008
Product of Pomerania 2007

Polish Federation of Engineering
Associations



Product of Koszalin 2014
Product of Koszalin 2013
Product of Koszalin 2010
Product of Koszalin 2009
Product of Koszalin 2008
Product of Koszalin 2007
Product of Koszalin 2006

Polish Federation of Engineering
Associations



Koszalin Denar 2015
Koszalin Denar 2014

Aqua Whirl WKG | Whirlpool bath tub for upper limbs



Tubs are perfect for hydro massage treatment of limbs and post-injury conditions, in nervous system disorders or muscular and nervous system fatigue.

Standard accessories:

- Swivel chair



Packing dimensions: **93 x 100 x 160 cm** Weight: **+20 kg**



Length: **90 cm**



Height: **92 cm**



Width: **95 cm**



Weight: **50 kg**



Capacity: **48 l**

Features:

- Basin available in two colours: white or calypso green
- Basin made of high quality acrylic (fibreglass mat reinforced)
- Economical use of water – min. 43 l, max. 48 l
- Effective hydro massage therapy via 44 nozzles
- „Dry-run“ pump protection system
- Adjustable air supply system for the water nozzles
- Electronically controlled descaling system
- Timer: 1-9h:59 min
- Electronic control panel
- Short filling and draining time
- Big diameter drain and filling system
- Semi-automatic draining system
- Temperature sensor
- Water level sensor
- Shower
- Smooth, profiled treatment chamber
- Ergonomic design
- Automatic filling (option)

Technical data:

Treatment capacity [l]:	ca. 40
Volume up to overflow [l]:	48
Filling / drainage [min.]:	1,3/0,7
Number of aeration nozzles:	44
Power consumption [kW]:	0,9
Supply voltage [V/Hz]:	230/50
Dimensions (L x W x H) [cm]:	90 x 95 x 92
Weight [kg]:	50

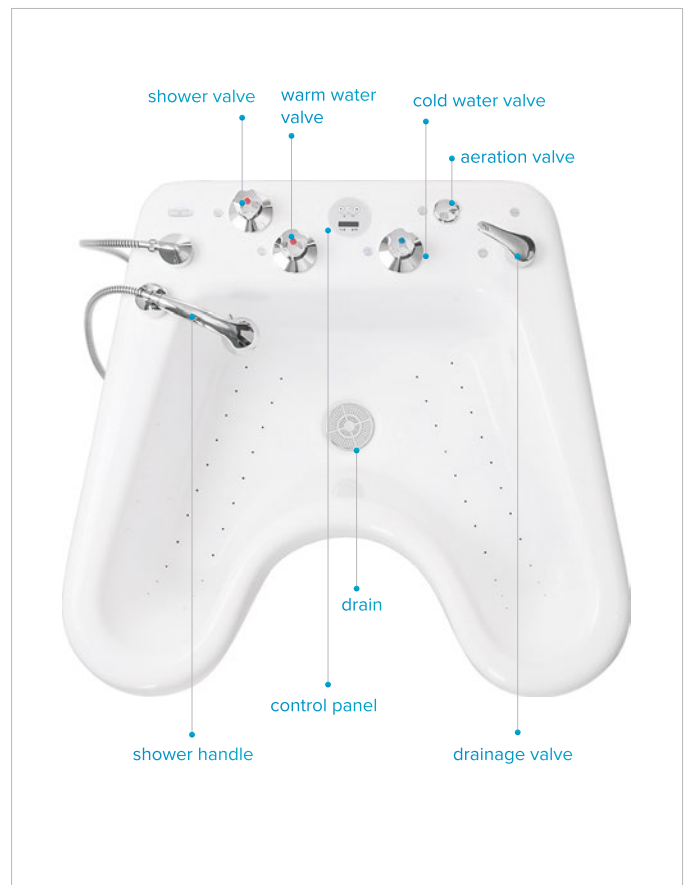

Aqua Whirl WKS | Whirlpool bath tub for lower limbs



Tubs are perfect for hydro massage treatment of limbs and post-injury conditions, in nervous system disorders or muscular and nervous system fatigue.



Packing dimensions: **94 x 103 x 135 cm** Weight: **+20 kg**



Length: **98 cm**



Height: **62 cm**



Width: **90 cm**



Weight: **49 kg**



Capacity: **62 l**

Standard accessories:

- Swivel chair

Features:

- Basin available in two colours: white or calypso green
- Basin made of high quality acrylic (fibreglass mat reinforced)
- Economical use of water – min. 40 l, max. 62 l
- Effective hydro massage therapy via 38 nozzles
- Adjustable air supply system for the water nozzles
- „Dry-run“ pump protection system
- Electronically controlled descaling system
- Electronic control panel
- Timer: 1-9h:59 min
- Short filling and draining time
- Big diameter drain and filling system
- Semi-automatic draining system
- Temperature sensor
- Water level sensor
- Shower
- Smooth, profiled treatment chamber
- Ergonomic design
- Automatic filling (option)

Technical data:

Treatment capacity [l]:	ca. 40
Volume up to overflow [l]:	62
Filling / drainage [min.]:	1,7/0,7
Number of aeration nozzles:	38
Power consumption [kW]:	0,9
Supply voltage [V/Hz]:	230/50
Dimensions (L x W x H) [mm]:	98 x 90 x 62
Weight [kg]:	49



Aqua Whirl WKD

Whirlpool bath tub for lower extremities



Tubs are perfect for hydro massage treatment of limbs and post-injury conditions, in nervous system disorders or muscular and nervous system fatigue.

Standard accessories:

- Steps



Packing dimensions: **80 x 120 x 120 cm** Weight: **+20 kg**



Length: **118 cm**



Height: **81 cm**



Width: **62 cm**



Weight: **56 kg**



Capacity: **154 l**

Features:

- Basin available in two colours: white or calypso green
- Basin made from gelcoat (fibreglass mat reinforced)
- Economical use of water – min. 120 l, max. 154 l
- Effective hydro massage therapy via 6 adjustable direction jet nozzles
- „Dry-run” pump protection system
- Massage intensity adjustment by supplying air to the jet nozzles
- Electronically controlled descaling system
- Electronic control panel
- Timer: 1-9h:59 min
- Temperature sensor
- Water level sensor
- Automatic filling
- Semi-automatic draining system
- Shower
- Smooth, profiled treatment chamber
- Ergonomic design

Technical data:

Treatment capacity [l]:	ca. 120
Volume up to overflow [l]:	154
Filling / drainage [min.]:	4/3
Number of aeration nozzles:	6
Power consumption [kW]:	0,9
Supply voltage [V/Hz]:	230/50
Dimensions (L x W x H) [cm]:	118 x 62 x 81
Weight [kg]:	56



Aqua Whirl WKR | Whirlpool bath tub for lower extremities and spine



Tubs are perfect for hydro massage treatment of limbs and post-injury conditions, in nervous system disorders or muscular and nervous system fatigue. It delivers effective 2-zone massage.

Standard accessories:

- Steps

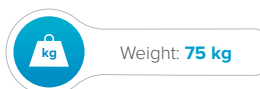
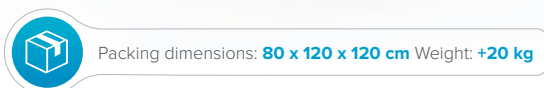

Features:

- Basin available in two colours: white or calypso green
- Basin made from gelcoat (fibreglass mat reinforced)
- Economical use of water – min. 75 l, max. 210 l
- Effective hydro massage therapy via 12 adjustable direction jet nozzles
- 2 levels of massage: I: lower limbs (75/145 l), II: lower limbs + spine
- „Dry-run” pump protection system
- Massage intensity adjustment by supplying air to the jet nozzles (independently for each zone)
- Electronically controlled descaling system
- Electronic control panel
- Timer: 1-9h:59 min
- Temperature sensor
- Water level sensor
- Automatic filling
- Semi-automatic draining system
- Shower
- Smooth, profiled treatment chamber
- Ergonomic design

Technical data:

Treatment capacity [l]:	75-210
Volume up to overflow [l]:	210
Filling / drainage [min.]:	2/3,5
Number of aeration nozzles:	12
Power consumption [kW]:	1,5
Supply voltage [V/Hz]:	230/50
Dimensions (L x W x H) [cm]:	116,5 x 68 x 95,2
Weight [kg]:	75



Aquanea | Therapeutic bath tub for SPA and thalassotherapy



Aquanea - therapeutic bath tub for SPA and thalassotherapy applications with automatic zone hydro massage is a blend of the newest technology, modern design and ergonomic shape.

Standard accessories:

- Steps
- Headrest

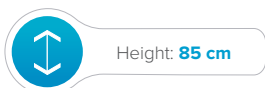
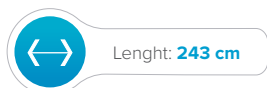
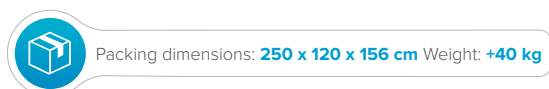

Features:

- Basin available in two colours: white or calypso green
- Basin made of gelcoat (fiberglass mat reinforced)
- Economical use of water during treatment - min. 180l, max. 250l,
- 188 hydro massage nozzles working simultaneously
- 62 aeration nozzles with intensity adjustment
- Massage intensity adjustment by supplying air to the nozzles
- Ozone generator
- Automatic disinfecting and descaling system
- „Dry-run” pump protection system
- Automatic canal's rinsing and drying system
- Automatic filling with a thermostat
- Automatic draining
- 2 temperature sensors (measurement while filling the bath and during the treatment)
- 2 water level sensors
- Timer: 10-30 min
- Multifunctional electronic control panel with easily accesible menu
- Shower
- One button start

Treatment possibilities:

- Whirl massage via 188 nozzles,
- Air bubble massage - aeration via a system of 62 nozzles,
- Chromotherapy (CHROMO),
- Baths in clear water or with addition of mineral salts, algae etc. (AROMA),
- Possibility to combine some functions (e.g. air bubble bath with ozone).

Technical data:

Treatment capacity [l]:	180-250
Volume up to overflow [l]:	275
Filling / drainage [min]:	<4
Power consumption [kW]:	3,6
Supply voltage [V/Hz]:	400/50
Dimensions (L x W x H) [mm]:	243 x 115 x 85
Weight [kg]:	220

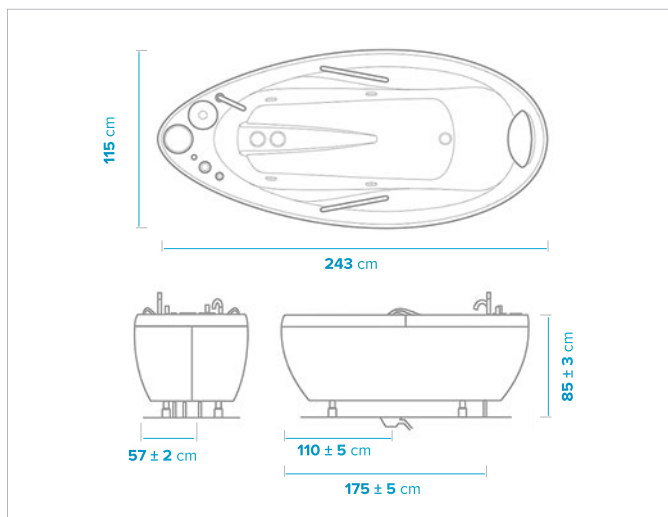

Additional options:

- ZONES 9:** 9 independent zones, 5 standard programs, 3 user programs
- CHROMO 2R:** chromotherapy: 2 lamps
- CHROMO 4R:** chromotherapy: 4 lamps
- CHROMO 12:** chromotherapy: 12 single light sources
- CHROMO 24:** chromotherapy: 24 single light sources
- CHROMO 36:** chromotherapy: 36 single light sources
- AUDIO:** sound input from an external device such as Hi-Fi, mp3 etc.
- AROMA:** scent container, dosage during treatment by pressing a button



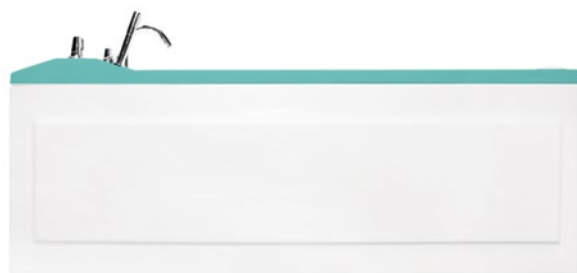

Orionmed | Bath tub for body relaxation and healing massage



Orionmed is one of the most versatile hydrotherapy bath tubs available on the market. Ergonomic design ensures treatment very comfortable for the patient, it also provides low water consumption. **Orionmed** bath tub is designed to provide relaxation and therapeutic hydromassage all over body in three independent zones, manual whip underwater massage, pearl bath and chromotherapy treatments.

 Packing dimensions: **240 x 120 x 129 cm** Weight: **+40 kg**

 Length: **214 cm**

 Height: **85 cm**

 Width: **85 cm**

 Weight: **170 kg**

 Capacity: **320 l**

Features:

- Basin available in two colours: white or calypso green
- Basin made of high quality acrylic (fibreglass mat reinforced)
- Economical use of water – min. 160 l, max. 280 l
- 26 nozzles for hydro massage divided into 3 independent zones (8, 8, 10 nozzles)
- 126 aeration nozzles for air bubble massage (with intensity adjustment)
- Massage intensity adjustment by supplying air to the nozzles independently for each zone
- Timer: 5-30 min.
- Ozone generator
- Independent air pump
- Disinfection and descaling system
- Automatic filling
- Semi-automatic drainage - water discharge lever
- „Dry-run” pump protection system
- Draining system for removing water from the piping system
- Easy accessible modern colour touch panel
- 2 temperature sensors (measurement while filling the bath and during the treatment)
- Heating system maintains water temperature automatically
- Warm and cold water shower
- Rails for palm support and specially shaped parts for arms and legs that facilitate appropriate body position during treatment sessions
- 2 water level sensors
- 3 standard programs: P1, P2, P3, 1 user program (P4)

Technical data:

Treatment capacity [l]:	160-280
Volume up to overflow [l]:	320
Filling / drainage [min]:	ca. 4
Power consumption [kW]:	4,5
Water jet pressure [bar]:	0-3,5
Supply voltage [V/Hz]:	230/50
Dimensions (L x W x H) [cm]:	214 x 85 x 85
Weight [kg]:	170 (195 fully equipped)

Standard accessories:

- Steps
- Headrest

Sections:

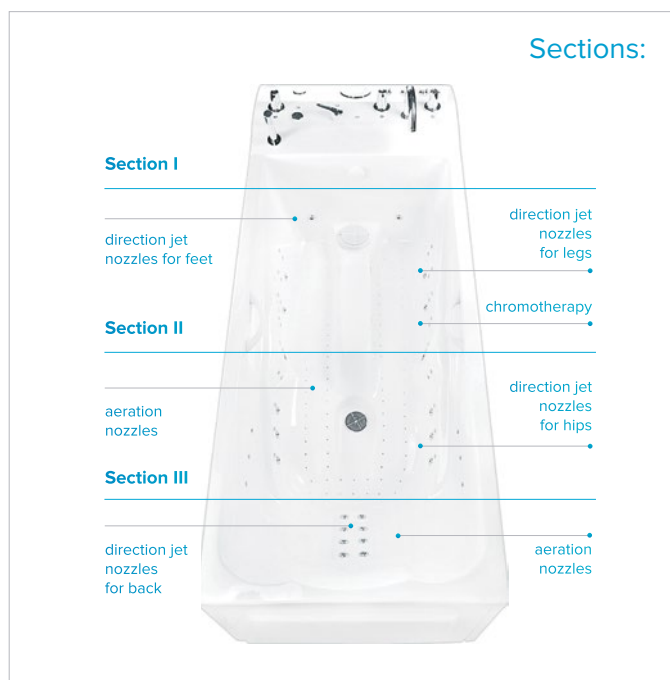

Additional options:

- HOSE:** jet hose for manual massage
- CHROMO 2R:** chromotherapy: 2 lamps
- CHROMO 12:** chromotherapy: 12 single light sources
- CHROMO 24:** chromotherapy: 24 single light sources
- CHROMO 36:** chromotherapy: 36 single light sources
- AUDIO:** sound input from an external device such as Hi-Fi, mp3 etc.
- AROMA:** scent container, dosage during treatment by pressing a button
- FOOTREST:** support for feet



Aquameden | Underwater massage bath tub



Elegant, robust body made of high quality acrylic resin reinforced with polyester laminate and seated on 4 adjustable height supports with rubber protective caps. Four sides of the bath tub protected by shaped laminate covers.



Packing dimensions: **240 x 120 x 129 cm** Weight: **+40 kg**



Length: **235 cm**



Height: **96 cm**



Width: **100 cm**



Weight: **195 kg**



Capacity: **550 l**

Features:

- Basin available in two colours: white or calypso green
- Basin made of high quality acrylic (fibreglass mat reinforced)
- Underwater massage jet hose
- Replaceable nozzle tips for the jet hose (option)
- Pressure indicator (up to 4,5 bar)
- Optional hydro massage: 8 side direction jet nozzles + 3 direction jet nozzles for back
- Massage intensity adjustment by supplying air to the nozzles
- „Dry-run” pump protection system
- Electronic control panel
- Timer: 1-9h:59 min.
- Water level sensor
- Water supply system using copper and PVC pipes (except connectors and valves)
- Automatic water installation disinfection system
- 2 water temperature sensors (readings taken while the tub fills up with water and during the treatment)
- Railings and feet supports helping to maintain proper body position during treatment
- Shower

Technical data:

Treatment capacity (minimum) [l]:	250
Volume up to overflow [l]:	550
Filling / drainage [min]:	6,0/4,5
Water jet pressure [bar]:	0-4,5
Power consumption [kW]:	2,4
Supply voltage [V/Hz]:	230/50
Dimensions (L x W x H) [cm]:	235 x 100 x 96
Weight [kg]:	195

Standard accessories:

- Steps

Treatment possibilities:

- Manual underwater massage using a water jet with stepless water pressure control
- Automatic hydromassage using hydromassage nozzles (JETS 11)
- Chromotherapy (CHROMO)
- Aromatherapy (AROMA)



Additional options:

- AIR 56:** 56 aeration nozzles to air bubble massage, independent air pump
- JETS 11:** 11 nozzles for automatic hydro massage (2 x 4 for side + 3 for back)
- CHROMO 2R:** chromotherapy: 2 lamps
- CHROMO 4R:** chromotherapy: 4 lamps
- CHROMO 12:** chromotherapy: 12 single light sources
- CHROMO 24:** chromotherapy: 24 single light sources
- CHROMO 36:** chromotherapy: 36 single light sources
- AUDIO:** sound input from an external device such as Hi-Fi, mp3 etc.
- AROMA:** scent container, dosage during treatment by pressing a button



Orionmed Balneo

Bath tub for balneological hydromassage



Thanks to the new balneological bath tub **Orionmed Balneo** saline baths can be enriched with effective hydromassage with directional jets.

 Packing dimensions: **240 x 120 x 129 cm** Weight: **+40 kg**

 Length: **214 cm**

 Height: **85 cm**

 Width: **85 cm**

 Weight: **160 kg**

 Capacity: **320 l**

Features:

- Basin available in two colours: white or calypso green
- Basin made of high quality acrylic (fibreglass mat reinforced) - saline influence-resistant
- Economical use of water during treatment (160-280 l)
- 26 nozzles for hydro massage without zones (all nozzles work simultaneously)
- Colour touch panel
- Timer: 5-30 min
- „Dry-run“ pump protection system
- Disinfection and descaling system
- Automatic filling, draining
- Draining system for removing water from the piping system
- 2 temperature sensors (measurement while filling the bath and during the treatment)
- Special pump and fittings elements adapted to saline waters
- Rails for palm support and specially shaped parts for arms and legs that facilitate appropriate body position during treatment sessions
- Shower
- 2 water level sensors

Technical data:

Treatment capacity [l]:	160-280
Volume up to overflow [l]:	320
Filling / drainage [min]:	<2 / ca. 4
Power consumption [kW]:	2,1
Supply voltage [V/Hz]:	230/50
Dimensions (L x W x H) [mm]:	214 x 85 x 85
Weight [kg]:	160 (175 fully equipped)

Standard accessories:

- Headrest
- Steps

Treatment options:

- Balneotherapy: sodium chloride waters (saline waters), thermal waters, baths with addition of liquid mud (special liquid concentrate)
- Balneotherapy massage or regular water massage
- Beer baths
- Chromotherapy (CHROMO)
- Music therapy (AUDIO)

Brine baths - indications:

- Rheumatoid disease
- Joints and spine degenerations
- Post-traumatic osteoarthritis
- Increased muscle tone
- Neurosis
- Recurring respiratory infections
- Peripheral circulatory disorders

Additional options:

CHROMO 2R: chromotherapy: 2 lamps

CHROMO 12: chromotherapy: 12 single light sources

CHROMO 24: chromotherapy: 24 single light sources

CHROMO 36: chromotherapy: 36 single light sources

AUDIO: sound input from an external device such as Hi-Fi, mp3 etc.

FOOTREST: support for feet



Balmed | Brine and CO₂ bath tub



Balmed is a modern medical bath tub specially designed for balneology baths. It is ideal tub for health resort Facilities and SPA & Wellness centers.

Packing dimensions: **220 x 95 x 100 cm** Weight: **+40 kg**

Length: **195 cm**

Height: **76 cm**

Width: **75 cm**

Weight: **75 kg**

Capacity: **240/300 l**

Features:

- Basin made of high quality acrylic (fibreglass mat reinforced) resistant to temperature, some chemicals and mineral waters
- Basin available in two colours: white or calypso green
- Large diameter of drain for fast emptying of the bath tub
- Fittings and finishing elements are made of acid-resisting steel
- Ergonomically shaped basin
- Timer: 1-9:59 min (only with option AIR 64)
- Fast filling thanks to the use of two filling nozzles
- Water supply: warm and cold
- Shower
- Up to 3 types of media: water saturated with CO₂, warm or cold brine, warm or cold sulfide water
- Capacity dependent on version:
STANDARD: 150-300 l
ECO: use of water 140-240 l reducing treatment costs
- Temperature sensor

Treatment possibilities:

- Balneologic treatment: sodium chloride waters (saline waters) bicarbonate water, thermal water, sulfide water
- Baths with addition of liquid mud (special liquid concentrate)
- Bear baths
- Pearlet baths (AIR 64)
- Chromotherapy (CHROMO)

Additional options:

- AIR 64:** 64 aeration nozzles to air bubble massage, air heating system, independent air pump (not possible with mud baths)
- CHROMO 12:** chromotherapy: 12 single light sources
- CHROMO 24:** chromotherapy: 24 single light sources
- FOOTREST:** support for feet

Technical data:

	ECO	STANDARD
Treatment capacity (minimum) [l]:	140	150
Volume up to overflow [l]:	240	300
Filling* / drainage** [s]:	142/140	165/162
Number of filling nozzles:	2	2
Supply voltage [V/Hz]:	230/50	230/50

* 2x Ø 3/4" DN20, 5 bar

** Drain tube of min. 100 mm in diameter, ensuring the minimum flow rate of 3,5 l/s

Standard accessories:

- Steps

Available models:

Models:	Number of valves	Warm water	Cold water	Shower	Medium 1	Medium 2	Medium 3
Balmed ECO / STANDARD	3	●	●	●			
Balmed ECO / STANDARD	4	●	●	●	●		
Balmed ECO / STANDARD	5	●	●	●	●	●	
Balmed ECO / STANDARD	6	●	●	●	●	●	●

To order it is necessary to choose model and version, for example:
BALMED 6 STANDARD - tub allowing connect up to 3 types of media.





 Packing dimensions: **215 x 80 x 110 cm** Weight: **+40 kg**

 Packing dimensions: **240 x 80 x 140 cm** Weight: **+20 kg**

- 1. Safety valve
- 2. H₂O delivery system
- 3. CO₂ delivery system
- 4. Control panel
- 5. Saturator column
- 6. Safety valve drain
- 7. Saturated water drainage system

Carbosat is a modern device for baths in carbon dioxide. The device operates in a continuous mode - the user can retrieve the water saturated with CO₂ continuously, which allows to run 5 carbon dioxide treatments simultaneously.

Features:

- Water efficiently saturated with carbon dioxide (50 l/min.)
- High level of carbon dioxide saturation in water (2 g/l)
- Maximum number of connected Balmed bath tubs - 5
- Gauge indicating the pressure in the water supply network
- Electrowave automatically regulates the water supply
- Gauge indicating the pressure in the carbon dioxide supply network
- Electronic control panel
- Light indicates tank filling level
- Stainless steel tank (approx. 160 l) with ceramic rings, accelerating water saturation
- Safety guaranteed by usage of certified container

Technical data:

Efficiency [l/min.]:	50
CO ₂ saturation level [g/l]:	2
Dimensions (height x diameter) [cm]:	187 x 32,4
Weight [kg]:	140
Power consumption [W]:	60
Power supply [V/Hz]:	230/50

Carbomed is modern device for "dry" baths in carbon dioxide.

Carbon dioxide baths (CO₂) - indications:

- Rheumatic diseases
- Circulatory system illnesses
- Circulation disturbances of peripheral arterial vessels
- Burns and frostbites
- Hypo- and hypertonia
- Ulceration of shank
- Gangrene: diabetic, arteriosclerotic, angiospastic

Features:

- Fully automated treatment
- Effective and fast sealing of treatment chamber
- Automated refilling of CO₂ and circulation of gas inside treatment chamber allows stable and high gas concentration in treatment area
- Automated humidation of CO₂ increases efficiency of treatment since the start
- Gas temperature may be regulated from 30°C to 40°C (+/- 1°)
- Sound signal after end of treatment
- Controlled piping away of CO₂ after end of treatment
- Mobile bed construction
- Regulated position of head support

Technical data:

Dimensions (L x W x H) [cm]:	215 x 70x 98
Height of laying level [cm]:	59
Power supply [V/Hz]:	230/50
Usage of CO ₂ [l/min]:	average 18



Aquai | Device for dry hydromassage



AQUAI has wide range of uses: it is used in the wellness and fitness areas. It perfectly suits rehabilitation centers. It is also a very good option for relaxation rooms in companies.

A patient in a rehabilitation center or a guest in a SPA center can experience the beneficial power of hydrojet massage without getting wet. The massage is done through a layer of plastic coat.

 Packing dimensions: **255 x 135 x 130 cm** Weight: **+40 kg**

 Length: **237 cm**

 Height: **70 cm**

 Width: **114 cm**

 Weight: **190/410 kg**

 Capacity: **220 l**

Advantages of the treatment:

- Improvement in blood circulation and metabolism
- Increase in oxygen transport in muscles
- Improvement in movement range of extremities
- Tension relief
- Stress reduction and relaxation
- Well-being

Features:

- 6 programmable and independent zones
- Jets can work simultaneously or in zones
- Dry water massage nozzles with increased durability
- 6 standard programs
- 1 user program
- Membrane surface temperature setting: temperature adjustable from 30 to 40°C
- Adjustable treatment time (1-30 min)
- Delayed start at programmed number of hours
- Adjustable frequency and sequence of zones
- Integrated heating system
- Internal water cooling system maintains water temperature during preset hours regardless of the number of treatments
- No need to connect to water tap
- Easily accessible modern colour touch panel
- LED lighting at the base

Technical data:

Dimensions (L x W x H) [cm]:	237 x 114 x 70
Capacity [l]:	220
Weight (empty/filled with water) [kg]:	190/410
Max. load [kg]:	135
Power supply [V/Hz]:	230/50 or 400/50

Massage zones:

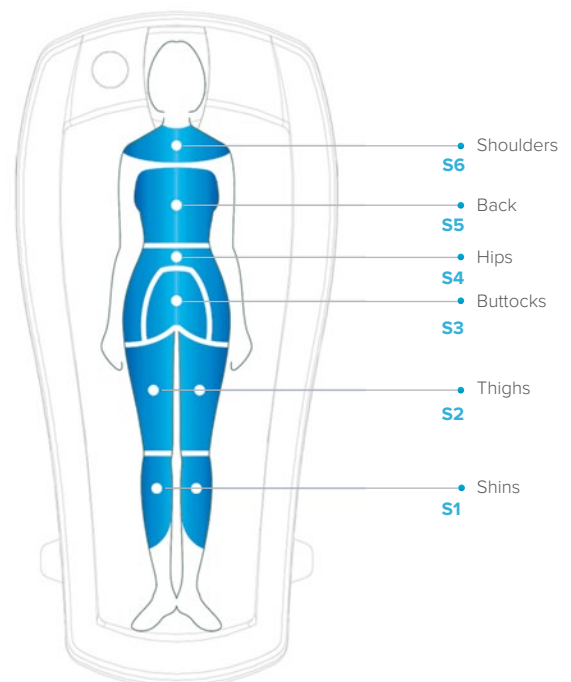

Additional options:

AUDIO: sound input from an external device such as Hi-Fi, mp3 etc.

CARD MANAGER: a system supporting the sale of treatment sessions using stored-value cards; together with top-up software.



Ekopompa

A closed-cycle water supply station for Aquavibron massage apparatus



The station makes it possible to conduct treatment procedures in a proecological manner with water circulating in a closed cycle producing vibrations in the membrane of the **Aquavibron** device. Procedures can be carried out at patient's bed. Closed water cycle makes the massage independent from the water supply and sewage disposal system. It utilizes all the advantages of Aquavibron.

 Packing dimensions: **55 x 80 x 104 cm** Weight: **+20 kg**

 Length: **63 cm**

 Height: **87 cm**

 Width: **50 cm**

 Weight: **40 kg**

 Capacity: **10 l**

Features:

- An environmentally-friendly device: low water consumption, no sewage
- Protection against electric shock with a differential current switch
- Adjustable massage force allows the therapist to set a gentle massaging intensity for more sensitive areas
- Water pressure is maintained by the pump supplied from the 230 VAC/50 Hz mains
- Ekopompa uses water stored in a built-in 10 litre tank
- Air flow forced by a fan ensures maintaining proper water temperature in the device
- 2 feet + 2 wheels (without brakes)
- Small dimensions
- Easy operation and functionality
- Easily connected to the original Aquavibron MEDIMARK device without conversions or modifications hindering its functionality
- High quality finish (steel handles, easily cleaned surface)
- Handle for the suspension of the Aquavibron apparatus
- Suitable for use in sanitariums, SPA centers and private surgeries

Technical data:

Container capacity min./max. [l]:	7-10
Power consumption [kW]:	0,6
Supply voltage [V/Hz]:	230/50
Dimensions (L x W x H) [mm]:	63 x 50 x 87
Weight [kg]:	40

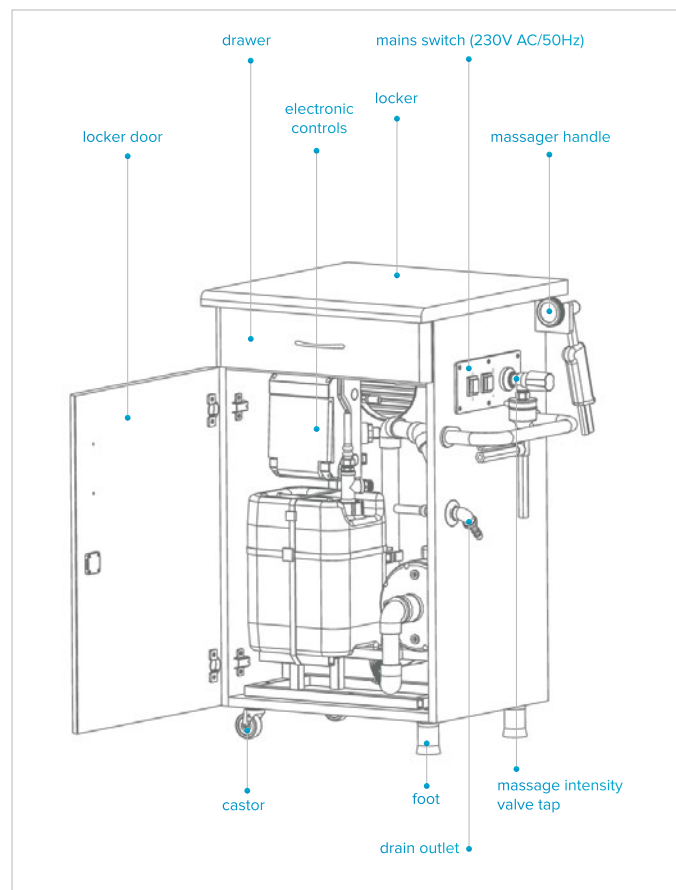

Aquamobil | Mobile water massage unit



Packing dimensions: **67 x 90 x 125 cm** Weight: **+20 kg**



Length: **42 cm**



Height: **95 cm**



Width: **67 cm**



Weight: **55 kg**



Pressure: **4 bar**

Advantages of the treatment:

Allows to perform professional underwater massage in standard tubs at SPAs, hospitals or home. Handheld hose with a set of interchangeable nozzles gives a relaxing, deep massage to the muscles or subcutaneous tissues.

Features:

- Fibreglass casing with special reinforcements
- Maximum mobility with 2 long, flexible hoses (massage and water feed)
- Robust, standalone unit with 4 castors with brakes
- Clean and simple top panel with elegant chromium-plated tap
- Pressure control gauge
- 3 interchangeable water nozzles
- Electronic control panel with thermometer
- Built-in disinfection system
- Pump „dry-run” protection
- Transport handles
- Power switch at the front of the apparatus

Technical data:

Pressure control [bar]:	0-4
Power consumption [kW]:	1
Supply voltage [V/Hz]:	230/50
Dimensions (L x W x H) [mm]:	42 x 67 x 95
Weight [kg]:	55
Length of hoses [m]:	2,5 (longer-option)





NPL2



Console packing dimensions: **86 x 71 x 130 cm** Weight: **55 kg**



Cage packing dimensions: **120 x 100 x 165 cm** Weight: **45 kg**

Bryza type NPL2* features:

- Free-standing console made from gelcoat reinforced with glass fiber
- Temperature control of one water source (1 thermostat)
- Lever for fast temperature changes
- Valve to regulate pressure and cut off the water
- Compensation tank for the reduction of small water pressure fluctuations in the water system
- Thermometer

Bryza type NPLE* features:

- Free-standing console made from gelcoat reinforced with glass fiber
- Temperature sensor
- Independent temperature control of two water sources (2 thermostates)
- Automatic changes of temperature between cold and warm water
- Electronic control panel with temperature indication
- Console has to be permanently connected to the electric system
- 3 standard programs, 4 user programs
- Compensation tank for reduction of small water pressure fluctuations in the water system

* There are possible versions with PUMP stabilizing pressure



Shower cabin **Bryza** is dedicated to conduct a therapeutic procedure using water massaging properties and temperature. Appropriately arranged water jets, spray water under high pressure, massaging the patient's body uniformly. Jet console **Bryza** allows the therapist to control the water pressure and temperature, whereby the treatment can influence the patient in different ways. Popular procedures include alternately showers during the treatment a rapid change of temperature is used.

Treatment possibilities:

- Cold and cool showers - with water temperature between 10-20°C. Shower lasts from a few seconds to a minute. Water showers toughen the body, stimulate metabolism and raise the blood pressure. Often used after hot hydrotherapy procedures, like balneological bath or sauna.
- Warm showers - with water temperature between 32-37°C. Shower lasts from 3 to 5 minutes. Recommended in neurosis, sleeplessness and neuralgias.
- Hot showers - water temperature between 38-42°C. Shower duration takes 5-10 minutes. It stimulates metabolism, increases sweating and vasodilation, lowers the blood pressure. Hot showers provide general relaxation and sedation of the patient.
- Cold / warm showers - water temperature 32-37°C for approx. 1 minute, then 10-20°C for approx. 30 sec. Shower duration should last for 5 minutes. It toughens the body, relaxes and stimulates metabolism of the patient.

Cage features:

- Piping of the shower cage is made from corrosion-resistant materials
- Shower cage is operated from a dedicated console NPL2 or NPLE
- Shower head
- 2 independent zones: 1-shower from above, 2-shower from sides

Technical data:

Cold and warm water pressure [bar]:	4-6
Warm water temperature [°C]:	max. 60
Power supply (applicable to NPLE and option with PUMP) [V/Hz]:	230/50
Installed power (applicable to NPLE) [W]:	max. 25
Power consumption (version with PUMP) [kW]:	0,8
Dimensions NPL2 (H x W x L) [cm]:	100 x 67 x 56
Dimensions NPLE (H x W x L) [cm]:	100 x 67 x 55
Dimensions CAGE (H x W x L) [cm]:	226 x 89 x 95





Packing dimensions: **86 x 71 x 130 cm** Weight: **55 kg**

Applications:

Orkan whip showers allow to use thermal and mechanical water properties during therapeutic treatment. Using stimuli provided by the stream of water and rapid water temperature changes, the therapeutic procedure can affect patient in different ways, for example: stimulate or sedate, increase or decrease the blood pressure.

Orkan type NBC1 features:

- Free-standing console
- 2 manometers and 2 thermometers (independent for each jet gun)
- Water jet dispersion adjustment (independent for both jet guns)
- The ability to work with two jet guns at the same time
- The jet guns rotatable within the treatment area
- The jet guns equipped with triggers initiating water massage (with a lock allowing for continuous massage) with forearm support
- 2 thermostatic taps for independent temperature adjustment for the two jet guns
- 2 water massage intensity (pressure) adjustment and shut-off valves independent for the two jet guns

Technical data:

Warm and cold water pressure [bar]:	4-6
Warm water temperature [°C]:	max. 60
Power supply (applicable to NBC2E) [V/Hz]:	230/50
Installed power (applicable to NBC2E) [kW]:	0,9
Dimensions NBC1 (H x W x L) [cm]:	115 x 67 x 55
Dimensions NBC2/NBC2E (H x W x L) [cm]:	100 x 71 x 55



Packing dimensions: **86 x 71 x 130 cm** Weight (NBC2/NBC2E): **56/59 kg**

Orkan type NBC2 features:

- Free-standing console
- Manometer, thermometer
- 3 jets (for pouring, scattered and dense water stream)
- Quick water temperature adjustment lever allowing for switching between hot water and cold water from the thermostates
- 2 thermostatic taps for smooth temperature adjustment (independent for cold and warm water)
- Compensation tank for the reduction of small water pressure fluctuation in water system
- 3 valves to regulate and cut off the pressure

Orkan type NBC2E features:

- Free-standing console
- The pump stabilizing pressure for use in case of low pressure in the water supply network
- Manometer, thermometer
- 3 jets (for pouring, scattered and dense water stream)
- Quick water temperature adjustment lever allowing for switching between hot and cold water from the thermostates
- 2 thermostatic taps for smooth temperature adjustment (independent for cold and warm water)
- 3 water massage intensity (pressure) adjustment and shut-off valves independent for each of the hoses
- Compensation tank

Accessories

Headrests:



Orionmed, Balmed



Aquai



Aquanea

Steps and chairs:



Rectangular steps without handrail (WKD, WKR, Orionmed, Aquameden, Balmed)



Oval steps without handrail (Aquanea)



Rectangular steps with handrail - option



Swivel chair (WKS, WKG)

Standard basin colours:



Calypso green

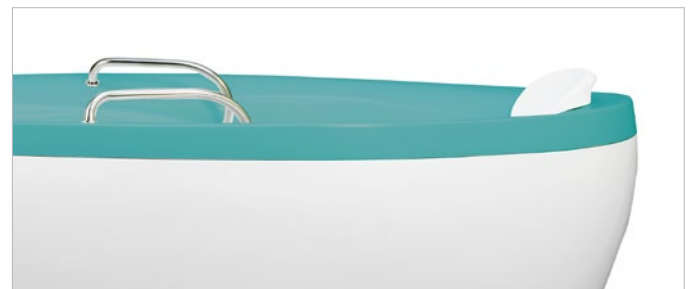

White

Products for maintenance:

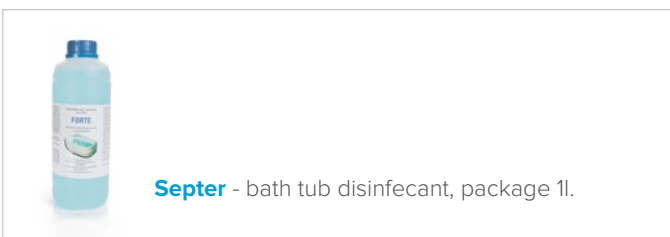

Septer - bath tub disinfectant, package 1l.

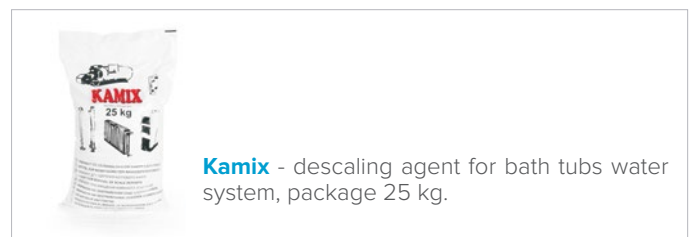

Kamix - descaling agent for bath tubs water system, package 25 kg.



Water Cycle Pro

Professional bike for resistance exercises in water



Packing dimensions: **120 x 80 x 150 cm** Weight: **+7 kg**

Water Cycle Pro is a professional bike for exercises in swimming pools (depth: 110-160 cm). Smooth adjustable resistance provides rehabilitation training and fitness activities.

Possibility of leveling the bike in pools with sloped bottom. Adjustment system allows taking a comfortable position during the training.

Features:

- Adjustment of the resistance by means of a knob
- Height adjustment
- Adjustment of saddle and handlebar position
- Transport wheels in front of bike for easy placing in water on the wall of the pool
- Frame made from stainless steel (316L), electropolished, with the highest resistance for pool environment
- Saddle adapted to work in water without losing its properties
- Stability, reliability and easy to use

Technical data:

Length [cm]:	105-121,5
Width [cm]:	65
Height [cm]:	112-153
Saddle height adjustment [cm]:	95-136,5
Handlebar height adjustment [cm]:	102-143 / 112-153
Height adjustment of axis level of the crank mechanism [cm]:	34-52,5
Adjustment of saddle sliding [cm]:	0-8
Adjustment of handlebar sliding [cm]:	0-12
Max. load [kg]:	≤ 150
Mass [kg]:	32

Application:

The device is used for the rehabilitation of people with spinal column problems, arthritis, problems with cardiovascular and respiratory system, as well as with osteoporosis.

Construction of the device allows to perform movements in the water without loading of the joints. It favors rehabilitation after injuries, operations and elimination of oedema.





Mobile hygiene chair with adjustable height and positioning is protected against water, dirt or hair while bathing, shaving or grooming the patient. Adjusted with a manual remote controller for optimal positioning of the patient. Mohican allows for an easy access to the shower and helps in moving the patient around at home or in care facilities of all kinds. Suitable for the elderly or people with all kinds of disabilities who might need help in taking care of their personal hygiene.

Product overview:



1. Lower frame including electric hi-lo actuator and 4 wheels with brakes
2. Upper frame with foldable armrests and electric actuator for backrest positioning
3. Seat that allows the patient to assume a comfortable position while caring for their personal hygiene
4. Adjustable, foldable footrests (removable without tools)
5. Manual remote control to adjust height and seat and backrest positioning



Packing dimensions: **120 x 80 x 140 cm** Weight: **+30 kg**

Product features:

- Grips for easy movement
- Waterproof, easy to clean backrest
- PU foam seat with an opening to help with patient hygiene
- Two waterproofed, dustproofed, battery-powered actuators
- Manual remote controller
- 4 blockable wheels
- Optional headrest for maximum comfort of the patient

Optional accessories:

- Adjustable chest belt - easy to use
- Velcro straps for legs - easy to remove and clean
- Extra battery - high-capacity pack for longer use

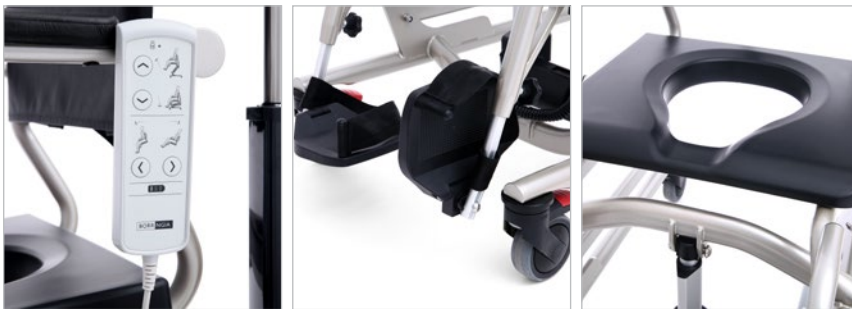

Technical data:

Size (LxW) [cm]:	110 x 57
Distance between armrests [cm]:	47
Seat tilt [°]:	+7 to -30
Max. load [kg]:	150
Weight [kg]:	44
Height adjustment [cm]:	53-93
Power [V]:	24





F-40, F-40/B, F-40/P



Packing dimensions: **80 x 80 x 96** cm Weight: **+15** kg

B-130L



Packing dimensions: **120 x 110 x 150** cm Weight: **+40** kg

C-14



Packing dimensions: **80 x 80 x 98** cm Weight: **+15** kg



F-40 - device for melting fango-paraffin mass for thermal therapy procedures and keeping it at a set temperature.

F-40/B, B-130L, B-200L - device for heating and mixing mud mass for thermal therapy procedures and keeping it at a set temperature.

F-40/P - device for melting paraffin mass for thermal therapy procedures and keeping it at a set temperature.

C-14 - device for heating and keeping the mass at a specified temperature range.

The electronic controller enables programming of the following functions:

- **Heating (F-40, F-40/P, F-40/B, B-130L, B-200L):** normal operation in range of temperature
- **Mixing (F-40, F-40/P):** forced mass mixing
- **Sterilization (F-40, F-40/P)**
- **Start in (F-40, F-40/P, F-40/B, B-130L, B-200L, C-14):** delayed start after a programmed number of hours
- **Constant work (C-14):** normal operation in range of temperature
- **Daily cycle (C-14):** time of the heating cycle (on/off) repeated daily

Features F-40, F-40/P, F-40/B, B-130L, B-200L:

- Used materials are resistant to corrosion (stainless steel)
- Special construction of the tank ensures minimum heat losses
- Microprocessor-controlled electronics guarantees minimum energy consumption
- Consists of a tank with a cover
- Mixer equipped with an automatic mixing arm
- Mixing arm is started every few minutes to maintain temperature and suitable consistency of the mass in the container
- Drain valve of the mixer is heated, which prevents the mass from congealing (F-40, F-40/P)
- The mixing arm drive is stopped automatically when the cover is lifted
- Adjustment of temperature
- Electronic controller
- Oil jacket (B-130L and B-200L)- very low energy consumption

Features C-14:

- For storing mass on trays placed inside the heating unit
- Heater with a fan keeps the preset temperature
- Microprocessor-controlled electronics and electronic controller
- Used materials are resistant to corrosion (stainless steel)

Technical data:

	F-40	F-40/P	F-40/B	B-130L	B-200L	C-14
Temperature range [°C]	55-80	55-80	30-60	30-60	30-60	25-80
Working volume of container [l]:	40	40	40	130	200	14 trays (40 x 60cm)
Sterilization temperature [°C]:	130	110	-	-	-	-
Power supply [V/Hz]:	400/50	400/50	400/50	400/50	400/50	230/50
Dimension (L x W x H) [cm]:	66 x 64 x 75	66 x 64 x 75	66 x 64 x 75	99 x 86 x 132	101 x 97 x 132	76 x 68 x 78
Power consumption [kW]:	2,3	2,3	2,3	3,3	3,6	2,3
Weight [kg]:	90	90	95	260 (360 with oil inside)	280 (380 with oil inside)	99







 Packing dimensions: **215 x 90 x 95 cm** Weight: **+30 kg**

 Length: **205 cm**

 Height: **61-94 cm**

 Width: **80 cm**

 Weight: **165 kg**

 Max. load: **150 kg**

Application:

Professional SPA resort or Wellness center requires highest quality equipment. To meet the needs of the most demanding customers we designed the Sophie couch. Exclusive 7-section couch is made with the highest care from materials providing trouble-free operation for many years. Aesthetic design will turn your working area into a unique place where everyone will feel special.

Features:

- 7-section massage couch with electric height adjustment by the means of a remote control
- Adjustment of position of 3 sections by means of a remote control
- Aesthetic design with built-in lifting mechanism
- Easy adjustment of couch sections
- Easy adjustment of headrest by means of gas spring
- Headrest with shaped face hole with plug
- Foldable armrests
- Possibility to rotate armrests horizontally (up to 90° outside)
- Multi-layer and very soft upholstery made of certified materials
- Foam layers resistant to deformation
- Security system to avoid unwanted change of settings; equipped with a magnetic access key
- 4 directional wheels with central blocking system

Technical data:

Number of sections:	7
Height adjustment [cm]:	61-94
Dimensions (L x W) [cm]:	205 x 80
Weight [kg]:	165
Max. lifting capacity [kg]:	150
Power supply [V/Hz]:	230/50

Table articulations:

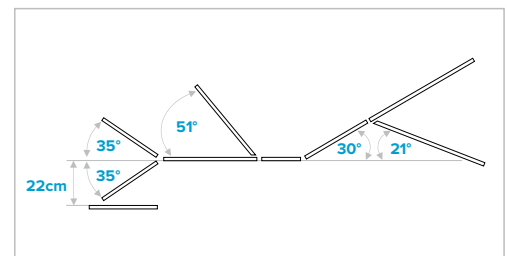

Additional options:

- Build-in surface heating system of table top (Comfort option)



Terapeuta Prestige

Line



Technical data:

	M-S2	M-S3	M-P3	M-S4	M-S5	M-P5	M-S7	M-P7	E-S2	O-S5	O-P5
Dimensions (length x width) [cm]:	202 x 69	205 x 69	205 x 69	202 x 69	205 x 69	205 x 69	205 x 69	205 x 69	205 x 69	205 x 59	205 x 59
Number of sections:	2	3	3	4	5	5	7	7	2	5	5
Head-rest inclination angle [°]:	-70/+40	-70/+40	-70/+40	-70/+40	-70/+40	-70/+40	-70/+40	-70/+40	0/+85	-70/+40	-70/+40
Middle section inclination angle [°]:	-	-	0/+30	--	-	0/+30	-	0/+30	-	-	0/+30
Foot-rest inclination angle [°]:	-	0/+85	-30/+85	-	0/+85	-30/+85	0/+85	-30/+85	-	0/+85	-30/+85
Height adjustment [cm]:	47-95	47-95	51-99	47-95	47-95	51-99	47-95	51-99	47-95	47-95	51-99
Weight FO/F4 [kg]:	80/95	85/100	95/110	87/102	92/107	102/117	95/110	105/120	80/95	92/107	102/117
Max. lifting capacity [kg]:	225	225	225	225	225	225	225	225	225	225	225
Power supply [V/Hz]:	230/50	230/50	230/50	230/50	230/50	230/50	230/50	230/50	230/50	230/50	230/50
Max. working load [kg]:	350	350	350	350	350	350	350	350	350	350	350



Powerful electric motor



Adjustment of postural drainage



Breathing slot shaped to place the nose and chin

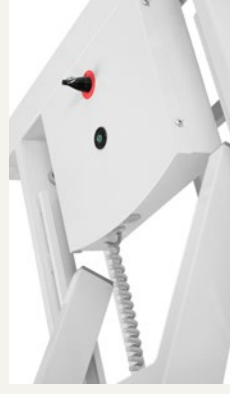

Personal Authorization Safety System (PASS)



Non-slip feet with 1 cm height adjustment

Safari Line



Technical data:

	Puma-S2	Puma-S4	Leopard-S3	Leopard-S5	Jaguar-P3	Jaguar-P5
Dimensions (length x width) [cm]:	202 x 69 (80)	202 x 69 (80)	205 x 69 (80)	205 x 69 (80)	205 x 69 (80)	205 x 69 (80)
Number of sections:	2	4	3	5	3	5
Head-rest inclination angle [°]:	-70/+40	-70/+40	-70/+40	-70/+40	-70/+40	-70/+40
Middle section inclination angle [°]:	-	-	-	--	0/+24	0/+24
Foot-rest inclination angle [°]:	-	-	0/+90	0/+90	-12/+90	-12/+90
Height adjustment [cm]:	49-95	49-95	49-95	49-95	51-97	51-97
Weight F0/F4 [kg]:	86/99	89/102	93/106	96/109	99/112	102/115
Max. lifting capacity [kg]:	200	200	200	200	200	200
Power supply [V/Hz]:	230/50	230/50	230/50	230/50	230/50	230/50
Max. working load [kg]:	300	300	300	300	300	300



Adjustment of head rest

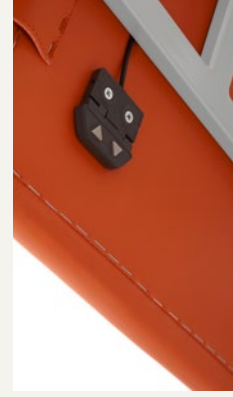

Adjustment of postural drainage

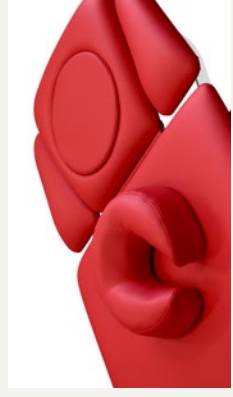

2 types of breathing slot cover:
round and crescent



Built-in surface heating system
of table top (Comfort option)



Personal Authorization
Safety System (PASS)

Production and R&D Department

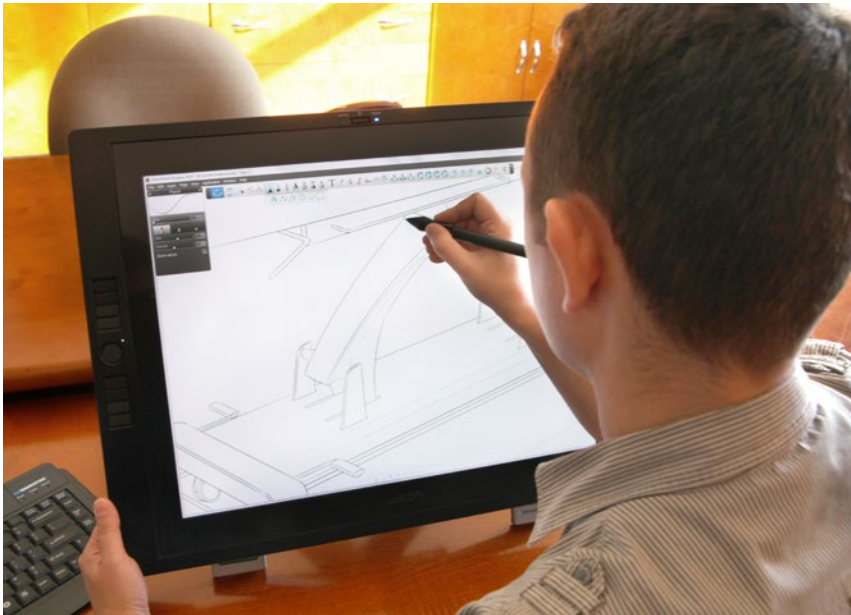

Since the very beginning of our work we produce professional medical devices. Thanks to the investments made, our production lines are equipped with the highest quality devices for mechanical and electronic production. In recent years we have expanded our facilities by purchasing CNC machining centers and powder painting shop. In addition to the excellent machinery, we are proud to boast a qualified research team, and experienced production staff.

Thanks to the modern production technology, the experienced designers team and close cooperation with medical industry representatives - our medical devices are appreciated in Poland and worldwide. Due to the extensive offer of manufacturing capabilities we also provide contract services in the field of design, development and final product manufacturing, based on our own documentation or the documentation provided by the customer.

We look forward to cooperating with you.

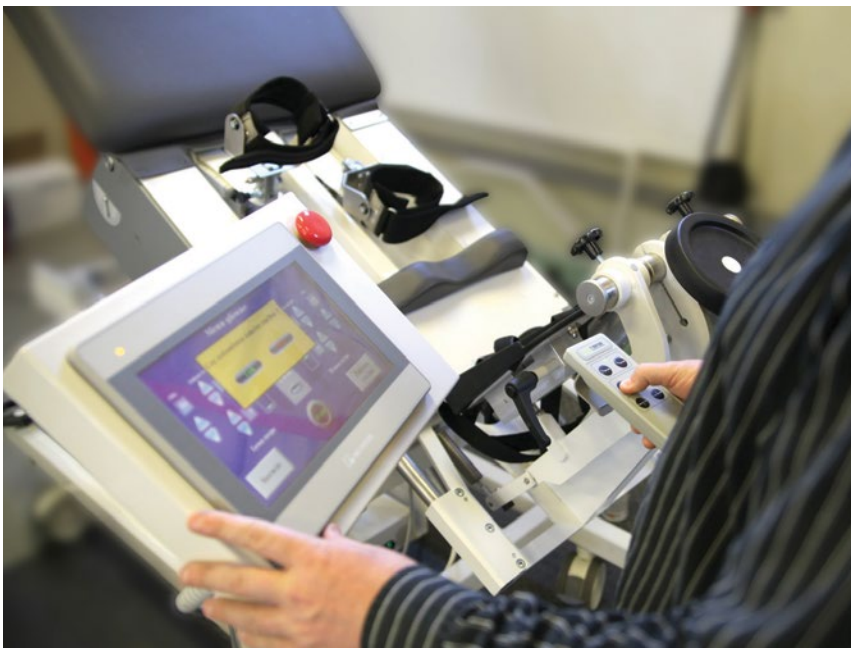

Modern powder painting line

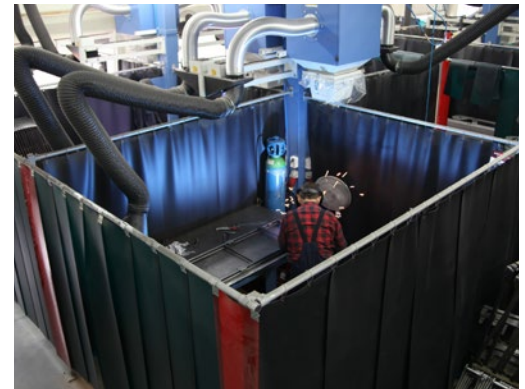

Welding shop



Laser

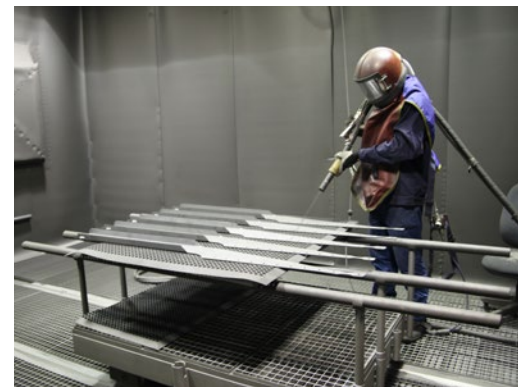

Sand blasting



MEDEN-INMED Sp. z o.o.

Wenedów 2, 75-847 Koszalin, Poland

Phone: +48 94 344 90 50, +48 94 344 90 78

Fax: +48 94 347 10 41

Mobile: +48 602 668 002, +48 601 646 866

E-mail: km@meden.com.pl, tg@meden.com.pl

www.meden.com.pl

